

M3 SM20 Series

User Manual

Version 1.1 © 2022

Korea Headquarter Seoul, Korea | sales@m3mobile.co.kr | +82-(0)2-574-0037

Europe Headquarter Frankfurt, Germany | sales_eu@m3mobile.net | +49-(0)-6190-8021829

www.m3mobile.net

Revision

Release date of version 1.0: Sep. 2021

- Initial distribution

Release date of version 1.1: Nov. 2022

- Add Scanner – SE55
- Change LTE-TDD frequency
- M3 Mobile GmbH Change Adresse

Terms of Use

Thank you for purchasing M3 SM20. This device provides high performance data collection and mobile communications that meet industrial standards.

This user manual enables users to know the characteristics of M3 SM20 series and how to use it.

- Please carefully read this manual before using the device to ensure safe and proper use, as well as to prevent accidents that may occur when the device is used.
- This manual is created based on current status. The details on this manual may be changed without prior notice.
- The descriptions of this manual are based on the device's default settings.
- Images and screenshots are described with the latest software version.
- This manual is created under the assumption that the device has all options. For detailed information on available options, contact the local distributor or refer to our Web site (<http://www.m3mobile.net>).
- M3 Mobile does not have any legal responsibility for any performance problem that may occur when a user uses an application that is supplied by a third party.
- M3 Mobile does not have any legal responsibility for any performance degradation or compatibility problem that may occur because of the user's mistake or negligence.
- M3 Mobile does not have any legal responsibility for copyright or patent breach by the user.
- M3 Mobile can request all or part of the applications developed by a user or a third party. The request is for the improvement of user environment or device performance.
- Higher OS version may be released after you purchase the device with the existing OS. If you want to receive information on the latest OS, please contact your local distributor.
- This device can be operated in at least one Member State without infringing applicable requirements on the use of radio spectrum.
- This manual may include technical or editing errors.

Copyright

Copyright © 2021 M3 Mobile Co., Ltd.

This manual is protected under international copyright laws. No part of this manual may be reproduced, distributed, translated, or transmitted in any form or by any means, electronic or mechanical, including photocopying, recording, or storing in any information storage and retrieval system, without the prior written permission of M3 Mobile.

Trademarks

- M3 Mobile and M3 logos are registered as trademarks of M3 Mobile.
- M3 SM20 is a registered trademark of M3 Mobile Co., Ltd.
- Google, Android, Google Play, YouTube, and other marks are trademarks of Google LLC.

Safety Rules

- Do not use the device while driving.
 - ✓ Traffic accidents may occur.
 - ✓ Observe the rules on device use while driving.
- Do not touch the power plug with wet hands.
 - ✓ You may be electrocuted.
- Be careful when using the battery.
 - ✓ Avoid causing a strong impact on the battery or breaking a hole through it with a sharp thing.
 - ✓ Do not put water on the battery or submerge it in water.
 - ✓ Do not let the charging terminal of the battery come into contact with a metal material.
- Keep the device, battery, or charger away from direct heat sources.
 - ✓ Heat may cause the device to become deformed, or an explosion or fire may occur.
 - ✓ If the device is placed inside a vehicle, the battery may explode due to increase in temperature.
- Do not use the device when there is thunder or lightning.
 - ✓ Lightning or fire may cause the device to break down or you may be electrocuted.
- Turn off power of the device when device use is prohibited.
 - ✓ Hazardous or wave-related problem may occur.
 - ✓ Turn off power of the device when you board a plane. The electromagnetic waves generated from the device may affect the plane's electronic equipment.
 - ✓ Turn off power of the device when you are in a hospital. Observe the device rules while in a hospital. The electromagnetic waves generated from the device may affect the medical equipment in the hospital.
- Turn off power of the device in hazardous areas where explosions may occur.
 - ✓ Observe the regulations, instructions, or signs of a hazardous area where explosions may occur.
 - ✓ Turn off power of the device while refueling.
- Be careful when a headset is used.

- ✓ Avoid long-term exposure to loud sounds to prevent damage to your hearing.
- ✓ Loud sounds while walking or driving distract your attention and may cause traffic accidents.

Instructional Icons

Before using this manual, please carefully read and understand the following icons:



Warning – Situations that may cause injury to yourself or others



Caution – Situations that may cause damage to your device or other equipment



Note – Notes, usage tips, or additional information

Table of Contents

Contents

| | |
|---|----|
| Contents | 6 |
| 1 Getting Started | 8 |
| 1.1 Package Contents | 8 |
| 1.1.1 Device and Accessories | 8 |
| 1.2 Battery | 9 |
| 1.2.1 How to use | 9 |
| 1.2.2 Charging the Battery | 10 |
| 1.3 Turning the Device On/Off | 12 |
| 1.3.1 Turning the Device On | 12 |
| 1.3.2 Turning the Device Off | 13 |
| 1.3.3 Standby Mode | 14 |
| 1.4 Memory Card | 15 |
| 1.4.1 Inserting an External Memory Card | 15 |
| 1.4.2 Checking Data | 15 |
| 1.5 SIM Card | 16 |
| 1.5.1 Inserting the SIM Card | 16 |
| 2 Basic Use | 17 |
| 2.1 Features | 17 |
| 2.2 Key | 17 |
| 2.2.1 Button | 17 |
| 2.3 Home Screen | 18 |
| 2.3.1 Status Bar | 18 |
| 2.3.2 Notification Bar | 19 |
| 2.3.3 Home Screen | 20 |
| 2.3.4 Dock Bar | 21 |
| 2.4 Data Input | 21 |
| 2.4.1 Virtual Keyboard | 21 |
| 2.5 Device Reset | 22 |
| 2.5.1 Soft Reset (1) | 22 |
| 2.5.2 Soft Reset (2) | 22 |
| 2.5.3 Factory Reset | 22 |

| | | |
|-------|--|----|
| 2.6 | Connecting with a PC..... | 25 |
| 2.6.1 | How to Connect..... | 25 |
| 3 | Using the Application Screen | 26 |
| 3.1 | Phone Function..... | 26 |
| 3.1.1 | Basics..... | 26 |
| 3.2 | Wi-Fi | 27 |
| 3.2.1 | Setting the Wi-Fi Feature..... | 27 |
| 3.3 | Scanner..... | 28 |
| 3.3.1 | How to Use Scanner | 28 |
| 3.3.2 | Using the Scanner | 29 |
| 3.4 | Bluetooth | 30 |
| 3.4.1 | Setting the Bluetooth Feature | 30 |
| 3.4.2 | Connecting Using Bluetooth..... | 31 |
| 3.5 | NFC..... | 32 |
| 3.5.1 | Setting the NFC Feature | 32 |
| 3.5.2 | Connecting the NFC Feature | 33 |
| 4 | Advanced Use | 34 |
| 4.1 | OS Update..... | 34 |
| 4.2 | Key Setting Conversion | 36 |
| 4.3 | Battery Hot swap | 38 |
| 4.4 | Fast Charging..... | 39 |
| 5 | Others | 40 |
| 5.1 | SM20 series Device Specifications..... | 40 |
| 5.2 | Service..... | 42 |
| 5.2.1 | Contacts..... | 42 |

1 Getting Started

1.1 Package Contents

1.1.1 Device and Accessories

The basic components of **M3 SM20** are as follows.

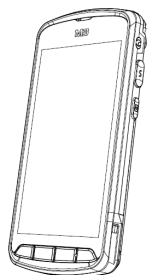

M3 SM20

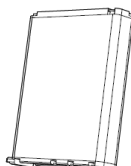

Battery

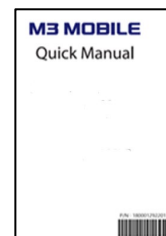

Quick Manual



Power Supply



USB Cable

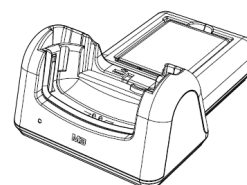

Cradle

If any components are missing or damaged, please contact the place of purchase.

※ NOTE

The cradle and all accessories are sold separately. Please refer to the SM20 accessory guide for details. The cradle is offered as a product for "charging and data synchronization" or "charging, data synchronization, and Ethernet connection" depending on the purchase option.

If the device is used for purposes other than the original device use or if it is remodeled, you may be exposed to electromagnetic waves.



1.2 Battery

1.2.1 How to use

Inserting the Battery

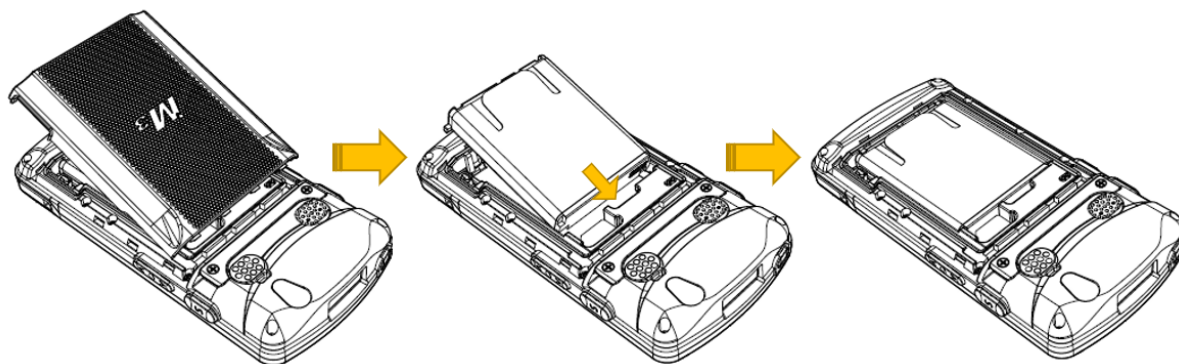
- Remove the battery cover before inserting the battery.
- Insert the battery from the bottom in the right direction.



M3 SM20 uses 3.8 V  4,100mAh Li-ion Battery, 3.8V  6,150mAh Li-ion Battery.



- If an unapproved battery is used, it may explode.
- When a battery is discarded, follow proper disposal procedure.
- Check if the battery is inserted in right direction.

Removing the Battery

- Press and hold the battery lock button on the side and remove the battery.

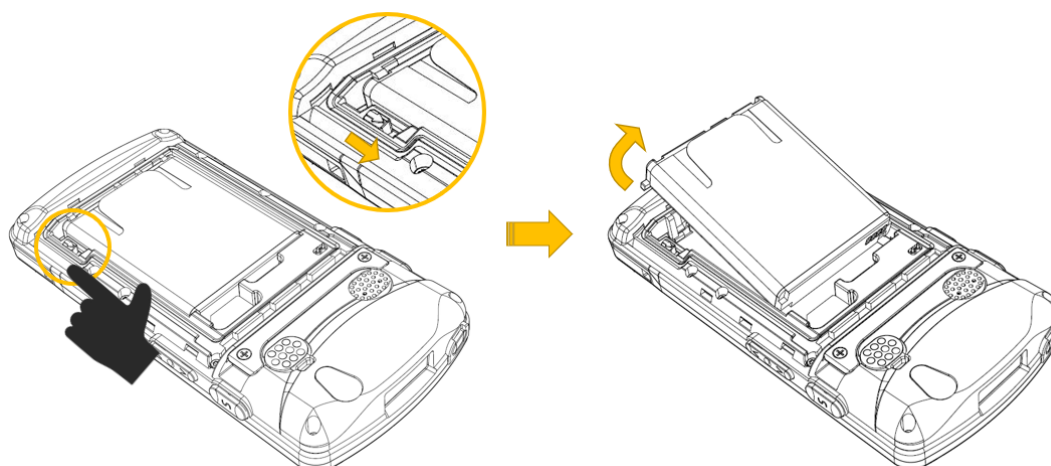



If the battery is not properly removed, the battery terminal may become bent or damaged.

Before the battery is removed, close any running program. If it is not closed, an error may occur in the program.

The elements of the instructional safeguard shall be as follows:

- elements 1a or 1b: not required
- element 2: “CAUTION” or equivalent word or text
- element 3: “Risk of fire or explosion if the battery is replaced by an incorrect type” or equivalent text
- element 4: optional

1.2.2 Charging the Battery

If the following battery warning screen is displayed, charge the battery.

If the device is continuously used without charging the battery, its power will be turned off.

Charging the Battery

- Please connect the device to a cradle that you can additionally purchase to charge the battery.
- As pictures below, Charging begins when you set a device into the cradle.

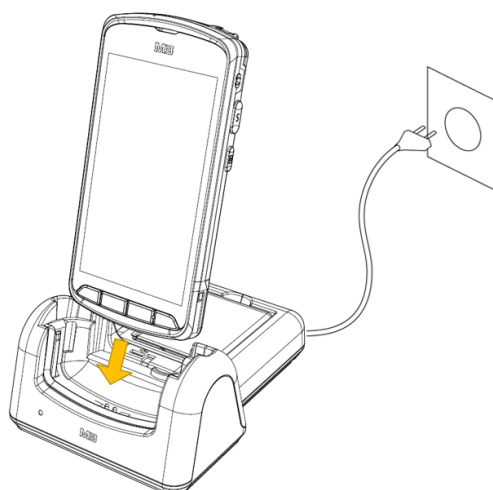

AC adaptor is made to be used in 100–240V input, 5V  5A output. If a voltage beyond the range is supplied, the device may be seriously damaged.

| LED Color | Description |
|-----------|---------------------------|
| Red | Battery is being charged. |
| Green | Battery is fully charged. |



If the battery is used at the temperature other than -20°C (-4°F) to 60°C (140°F), the device may malfunction or break down.

It takes about 4 hours to fully charge a battery that is fully discharged.



- It is recommended to replace a battery every two year.
- If a battery is charged and used continuously, its lifespan will decrease.

For information on the device battery, **Swipe the bottom** → Click  **Settings** → **Battery**

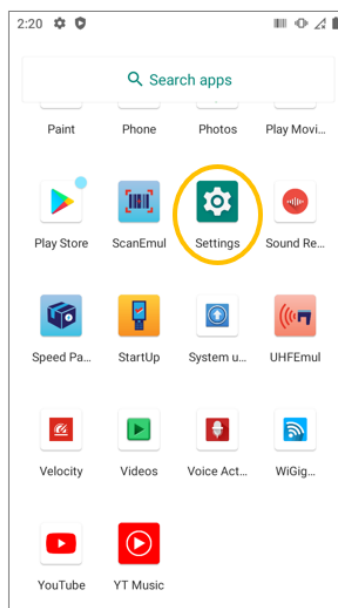
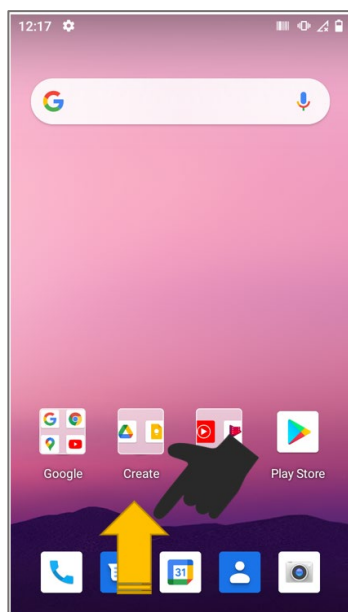

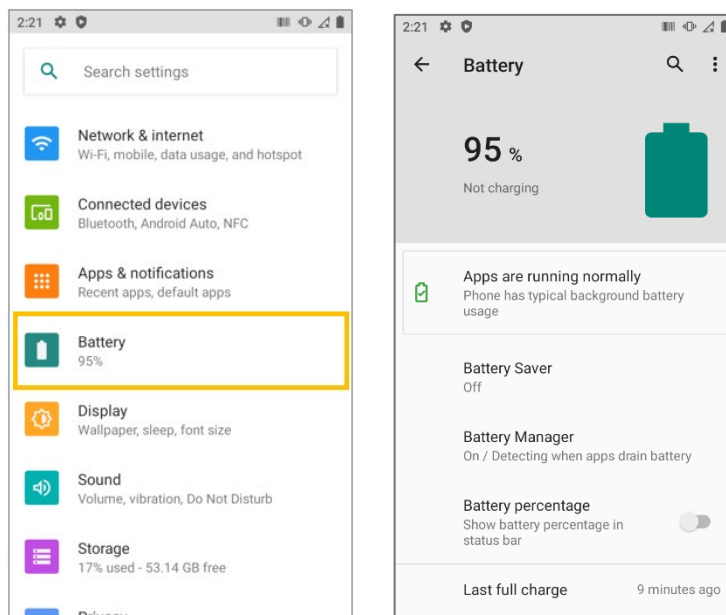

1.3 Turning the Device On/Off

1.3.1 Turning the Device On

Press and hold Power button until the device vibrates. This will turn the device on and initial screen will display.



If the battery is completely discharged, problems may occur when the device is turned on. If a problem occurs, charge the battery before turning on the device again.

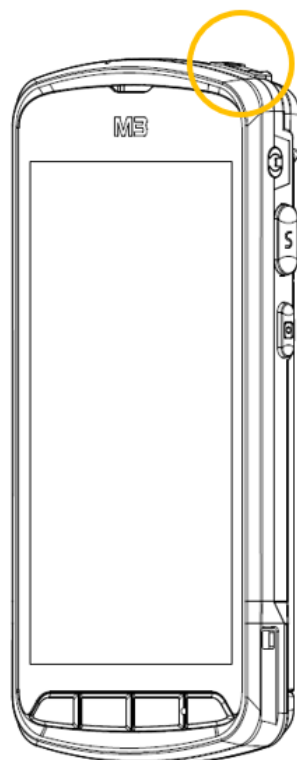

1.3.2 Turning the Device Off

Press and hold the Power button for about one second to display the following pop-up screen. Select the Power off menu to turn off the power.

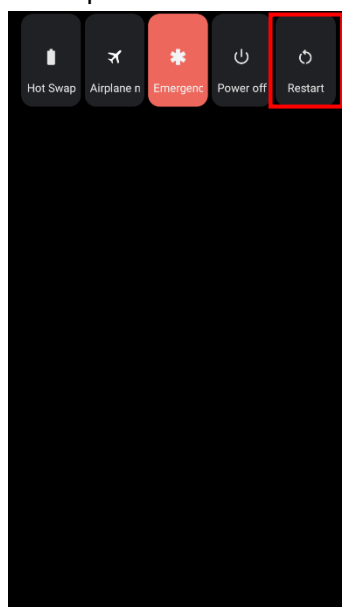

If the device stops its operation for a long time, press and hold the Power button for about eight seconds to forcibly reboot the device.

1.3.3 Standby Mode

If the device is not used for a long time, M3 SM20 automatically shifts to standby mode to decrease battery consumption. To manually set the device in standby mode, lightly press the Power button.

By default, if the device is not used for 30 seconds or longer, it shifts to standby mode. The time when the device shifts to standby mode can be set by the user.

Swipe the bottom → Click  Settings → Display → Sleep to change time that the device will shift to standby mode.

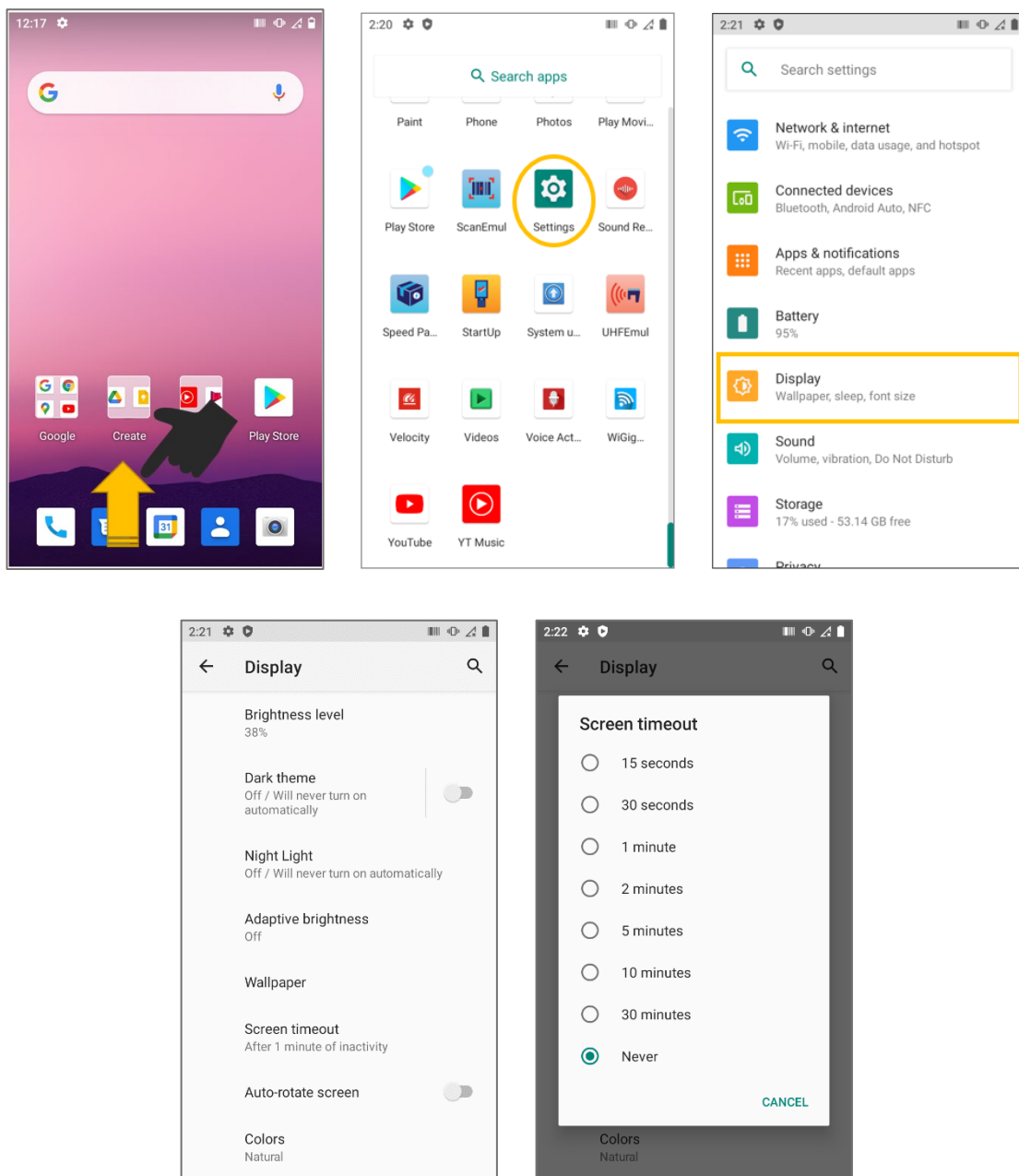

1.4 Memory Card

1.4.1 Inserting an External Memory Card

The Micro-SD card is used as an external memory of M3 SM20. After removing the battery, insert SD memory card into the Micro-SD card slot.

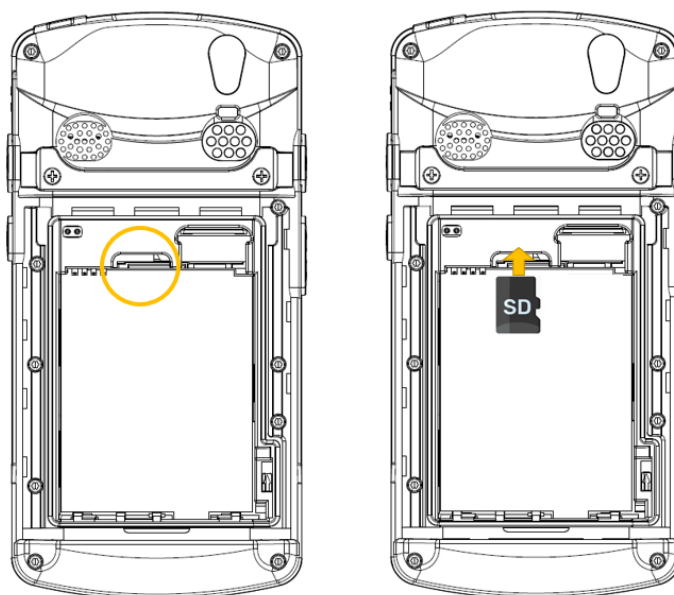



To insert a Micro-SD card, remove the battery cover on the back of the device and remove the battery.



Android™ 11, the OS used in M3 SM20, can support up to 512 GB for external memory.

1.4.2 Checking Data

Information stored in the Micro-SD card can be checked by swiping bottom → Click  Files

or  File manager → Menu → SD card

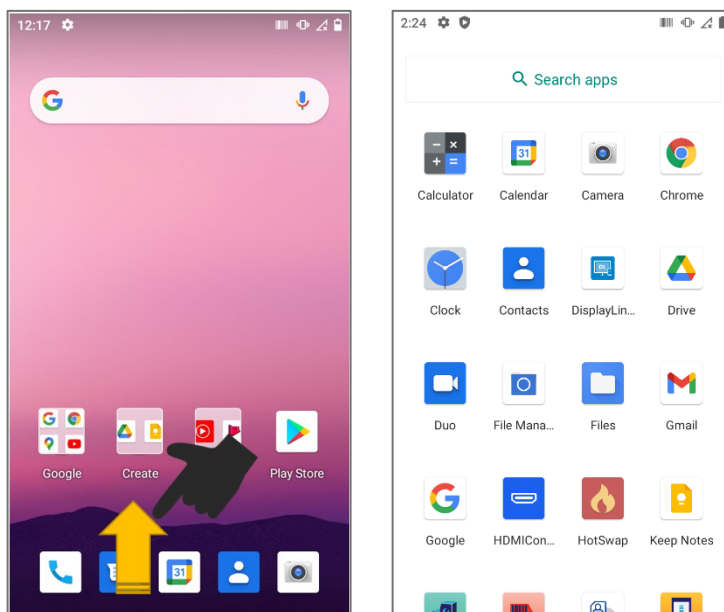

1.5 SIM Card

1.5.1 Inserting the SIM Card

SIM card supports voice call and data transfer through mobile communications. The card should be the one verified by a local network supplier.

To insert SIM card, remove the battery cover on the back of the device and remove the battery.

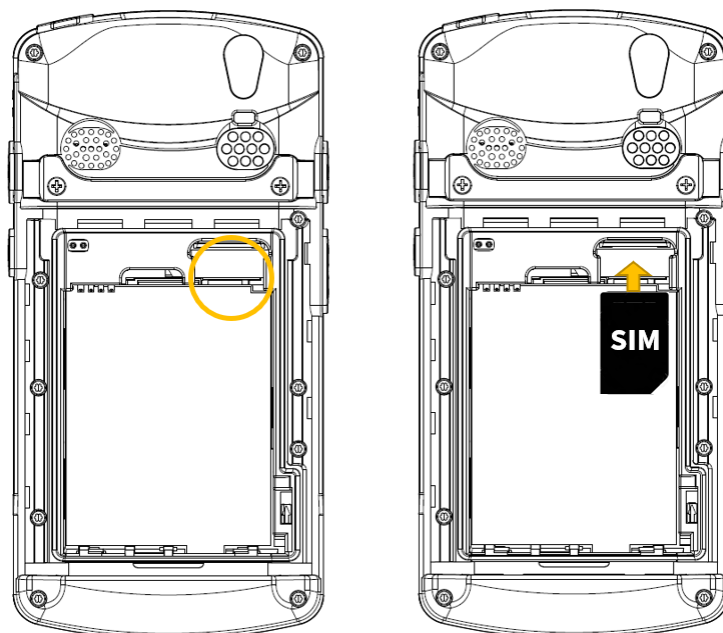

For more information on how to use the phone, please see [phone functions section](#).

2 Basic Use

2.1 Features

Device Layout

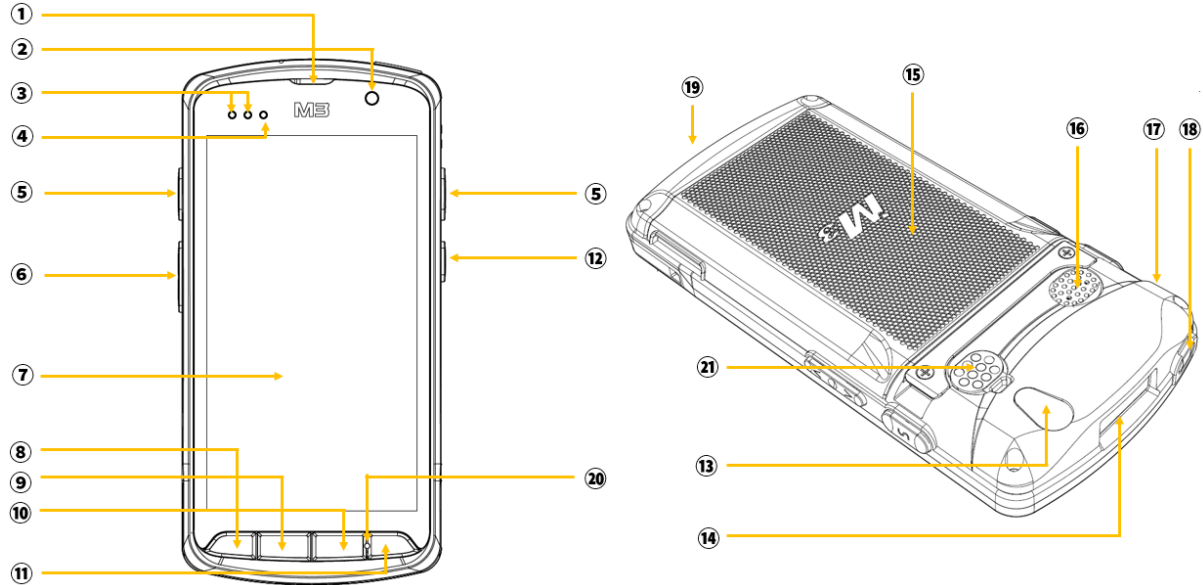

- | | | |
|------------------|-------------------|-----------------|
| ① Receiver | ⑧ Back Button | ⑮ Battery Cover |
| ② Front Camera | ⑨ Home Button | ⑯ Speaker |
| ③ Sensor | ⑩ Menu Button | ⑰ Ear Jack Hole |
| ④ Charging LED | ⑪ Function Button | ⑱ Power Button |
| ⑤ Scanner Button | ⑫ Camera Button | ⑳ Microphone |
| ⑥ Volume Button | ⑬ Rear Camera | ㉑ I/O Pin |
| ⑦ Screen | ⑭ Scan Window | |

2.2 Key

2.2.1 Button

| Button | Description |
|-------------|--|
| Scanner | Operate scanner while executing scanner program. |
| Function | Execute the work set to the button. |
| Volume High | Increase volume. |
| Volume Low | Decrease volume. |
| Menu | Display menu. |

| | |
|--------|---|
| Home | Go to Home screen. |
| Back | Return to previous stage. |
| Camera | Take pictures while executing camera program. |
| Power | Power on/off screen or shut off power |

2.3 Home Screen

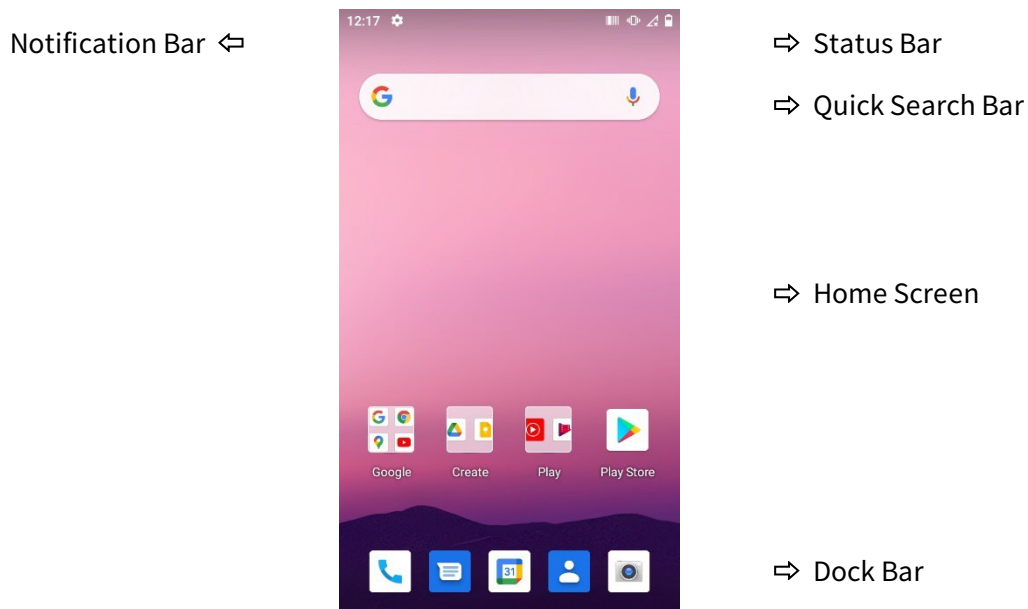

If the device is turned on, the following screen will be displayed. The screen is divided into six sections as follows:



2.3.1 Status Bar

















The Status Bar displays status of the device.

| Icon | Icon Name | Description |
|------|-------------------|--|
| | Battery | Battery charging status or battery residual capacity |
| | Phone | Call strength or no signal |
| | Sound / Vibration | Sound or Vibration status of the device |
| | Wi-Fi | Wi-Fi connection/disconnection |
| | Bluetooth | Bluetooth connection/disconnection |
| | GPS | Status of searching the location data |

| | | |
|---|---------------|------------------------------------|
|  | Alarm | Alarm activation status |
|  | Airplane Mode | Activation status of Airplane mode |
|  | NO SIM | SIM card is not connected |











2.3.2 Notification Bar

The Notification Bar displays device notifications.

| Icon | Icon Name | Description |
|---|-------------------------|---|
|  | More | There are more notifications. |
|  | Data Sync | Data is being synchronized. |
|  | Schedule | Displays the schedule. |
|  | Wi-Fi | Open Wi-Fi network can be used. |
|  | Music | Music is being played. |
|  | Data Sync | An error occurs when data is being synchronized. |
|  | Data Upload | Data is being uploaded. |
|  | Data Download | Data is being downloaded. |
|  | SD Card Full | Capacity of SD card is full. |
|  | USB | Device is connected through USB. |
|  | Debugging | USB debugging can be used. |
|  | Received Message | There is a message received. |
|  | Missed Call | There is a missed call. |
|  | Wi-Fi hotspot | Wi-Fi hotspot is activated. |
|  | USB tethering | USB tethering is activated. |
|  | Bluetooth tethering | Bluetooth tethering is activated. |
|  | Virtual Private Network | Device is connected to Virtual Private Network (VPN). |

2.3.3 Home Screen

On the Home Screen, there are shortcut icons of main programs. A shortcut icon can be added or deleted.

| Icon | Icon Name | Description |
|---|-------------------------|--|
|  | Google | Find what you need, explore your interests, and get a feed of stories and updates on topics that matter to you. |
|  | Gmail | Get your messages instantly via push notifications, read and respond online & offline, find any message quickly and lots more. |
|  | Google Chrome | Browse fast on a device with the same Chrome browser you love on your desktop. Pick up where you left off on your other devices with tab sync, search by voice, and save up to 60% of data usage while browsing. |
|  | Google Maps | Explore and navigate your world with Google Maps. Find places you'll love, connect with businesses you're interested in, and get around with real-time traffic information. |
|  | YouTube | See what the world is watching in music, gaming, entertainment, news and more. Subscribe to channels, share videos with friends, edit and upload videos, and watch on any device. |
|  | Google Drive | Google Drive is a smart online storage and backup that puts all your files within reach from a device. |
|  | YouTube Music | Easily find the albums, singles, live performances, covers and remixes you're looking for. Don't know a song's name? Just search the lyrics or describe it. |
|  | Google Play Movies & TV | Buy or rent the newest movies and shows way before they hit DVD — plus all your old favorites, too. |
|  | Google Play Music | Music makes it easy to find the right music, right now. Listen to millions of songs for any mood or situation, with recommendations from Google to help you navigate them. |
|  | Google Duo | Use to make a simple video call with the high-quality. |



Google Photos

Automatically organized and searchable by the people, places, and things in them, your photos and memories are always easy to find and share.







Google Play

Get your music, movies, TV, books, magazines, apps, and games all in one place.

2.3.4 Dock Bar

Shortcut icons can be placed on the lower section to rapidly execute frequently used programs. On the Dock Bar, up to five shortcut icons may be added or deleted.

| Icon | Icon Name | Description |
|---|-----------|-------------------------------------|
|  | Phone | Receive or make a call. |
|  | Calendar | Set, manage, or reserve a schedule. |
|  | Contacts | Manage address book. |
|  | Message | Receive or send a text message. |
|  | Camera | Take photos or record videos. |

2.4 Data Input

2.4.1 Virtual Keyboard

If focus is placed on the input screen, the virtual keyboard will be automatically displayed.

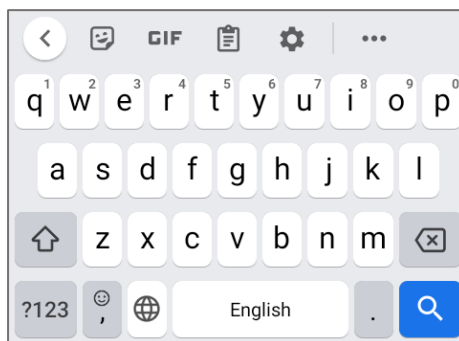

2.5 Device Reset

2.5.1 Soft Reset (1)

Press and hold Power button to display power management menu. Select “Restart” menu.

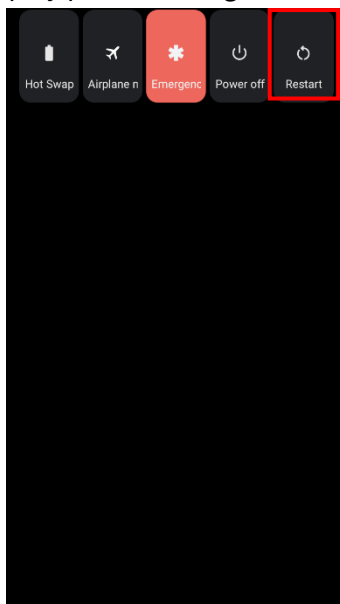

2.5.2 Soft Reset (2)

Long Press Power button more than 30sec.

The program being executed will end, and the data or file being used will also be deleted.

However, the stored data or file will not be affected by Soft Reset.

2.5.3 Factory Reset

If serious problem occurs in the device or problem is not solved through Soft Reset, Perform factory reset.

For factory reset, Perform the following procedure:

Swipe the bottom → Click  Settings → System → Reset options → Erase all data (factory reset)

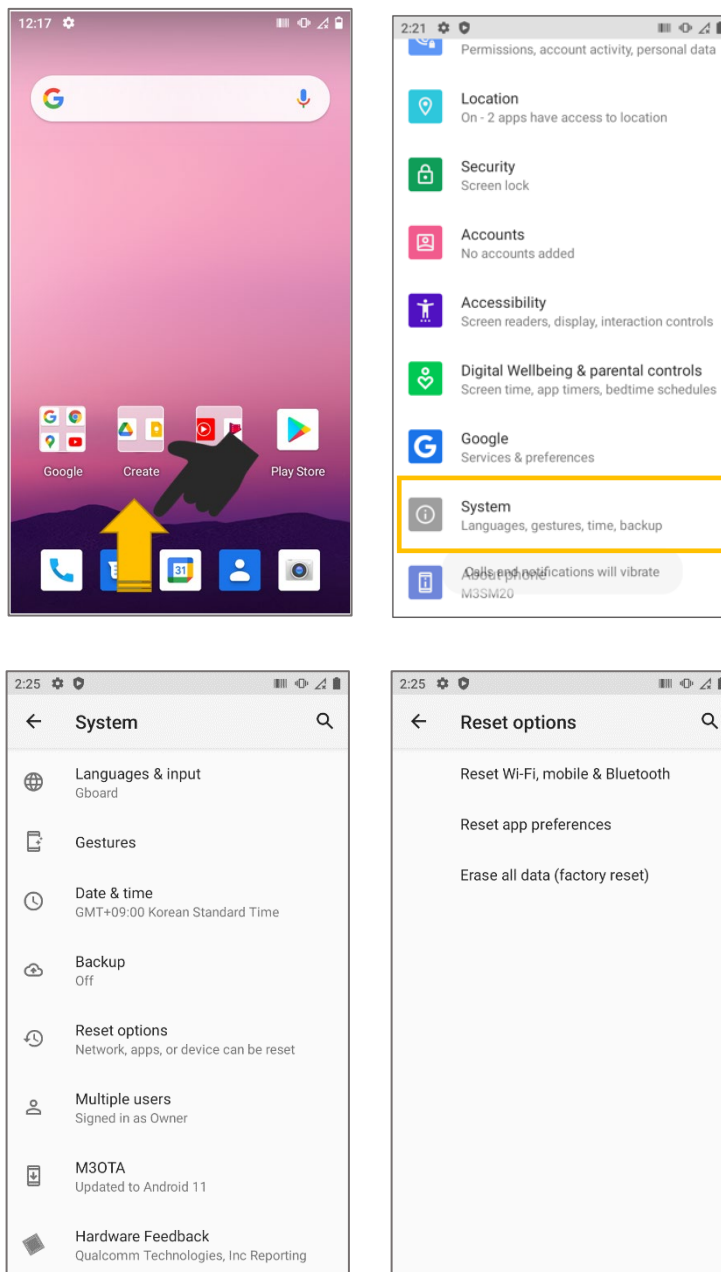

- Check if Erase internal SD card is checked. → Reset device. → Erase everything
- According to options, documents in internal SD card or Micro-SD card may be deleted. As such, please check the options. All settings will be reset.

Factory Reset Protection (FRP) Feature

- **What is Device Protection, or Factory Reset Protection (FRP)?**

Android devices provide built-in security features you can use to protect your device and information, including screen locks and data encryption. Data protection, or Factory Reset Protection (FRP), is a security feature on Android devices with Lollipop 5.1 or higher.

FRP is automatically activated when you set up Google Account on your device. Once FRP is activated, it prevents use of a device after factory data reset, until you log-in using Google username and password previously set up on the device.

- **How does FRP work?**

When you perform a Factory Data Reset, all settings are returned to the factory default settings. All data is erased including files and downloaded apps.

If you have a Google Account set up on the device, FRP is active. This means that after reset, you'll be required to log-in to the Google Account using the username and password. If you have multiple Google Accounts set up on the device, you can log-in using any of the accounts.

If an unauthorized person tries to reset the device by another method, the device would still require log-in using the Google username and password. This means that if your device is lost or stolen, another person would not be able to reset it and use it.

- **What do I need to know about FRP?**

If you want to reset your device to factory defaults, make sure you know your Google Account and password, because you'll need to log-in at the end of the reset.

If you want to reset your device to factory defaults, but don't remember your Google username and/or password, you can do one of these:

Check your device's Account settings for your account name and reset your password via the device or at <https://www.google.com>.

It can take 24 hours for the password reset to sync with all devices registered to the account.

Remove the account before you reset device.

If you already reset your device, but don't remember your Google username and/or password, the device can't be used. In that case, you can do one of these:

If you know your Google username but can't remember the password, you can reset your password on the device, or at www.google.com. It can take up to 24 hours for a new password to sync with all registered devices. After 24 hours, you can try to log-in your phone with the new password.

If you have multiple Google Accounts, and you can't remember which Google Account you set up on your device, visit <https://www.google.com/android/devicemanager>.

Log in with your Google username and password and check the list of devices registered to the account. If you don't see the device listed on the account, it means the device is registered to a different account. Use the same process to check for devices linked to your other Google Accounts. When you find the registered account, use it to log-in your device.

If you can't remember any of your Google Account information, you can send your device, along with proof of purchase, to an authorized M3Mobile supplier. M3 has special tools to reset the phone to factory defaults with no protection enabled.

2.6 Connecting with a PC

2.6.1 How to Connect

To connect the device to a PC, perform the following procedure:

1. Connect the device to a PC via cradle or USB. You can see screen as below.

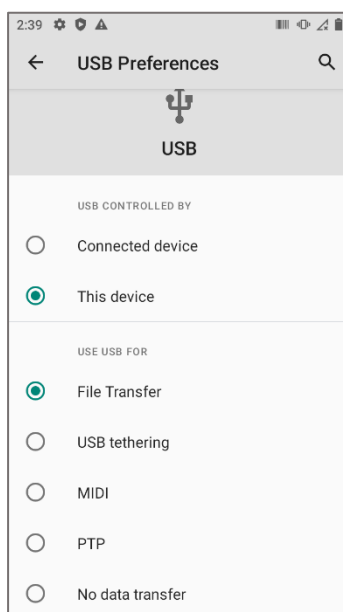

- Charge this device – This mode is only for charging a device. Data cannot be sent.

- File Transfer – Send files to another device.
 - PTP – Send photos or files.
 - MIDI – Use as Musical Instruments App.
2. PC recognizes the device and automatically installs driver.
 3. Once the driver is completely installed, file is transferred through Explorer.

If the device does not connect with a PC, check the following:



- Check if the USB cable is properly connected between the device and PC.
- Check if LCD screen of the device is turned on.

Check above and connect them again.

3 Using the Application Screen

3.1 Phone Function

M3 SM20 supports the 2G (GSM), 3G (UMTS, HSPA+) and 4G (LTE) networks.

3.1.1 Basics

Press the  icon to use the Phone menu.

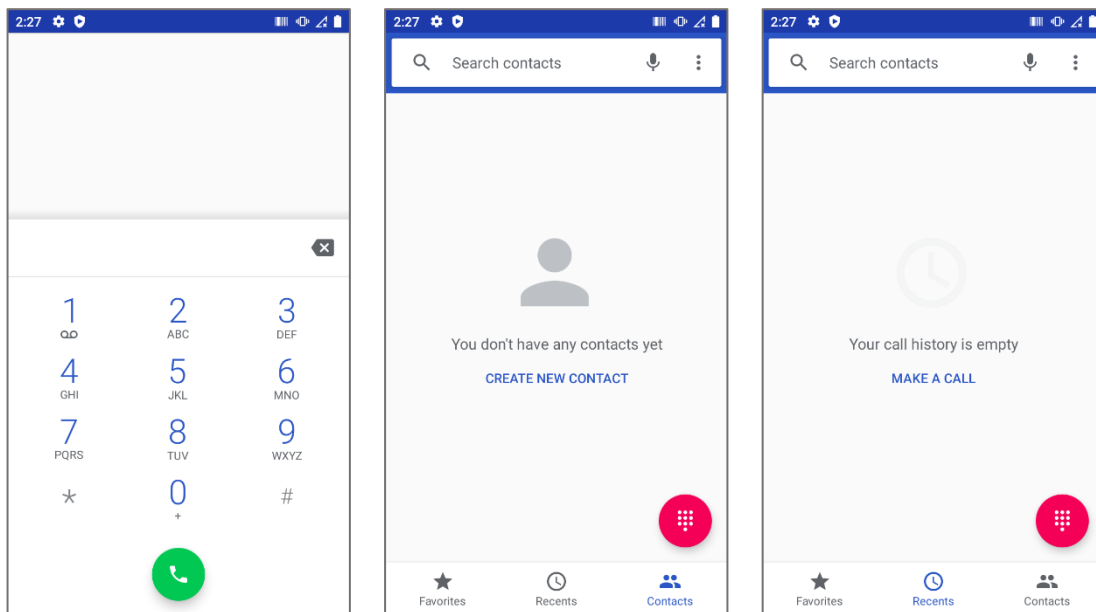

- Press the (🕒) icon to see the recent call history.
- Press the (👤) icon to see the contacts.
- Press the **Create new contact** to add a contact.



Before making a call or transferring data through network, make sure that the phone function is available.

3.2 Wi-Fi

3.2.1 Setting the Wi-Fi Feature

Activating the Wi-Fi feature

Swipe the bottom → Click  Settings and set the WLAN menu to ON/OFF to activate or deactivate the Wi-Fi feature.

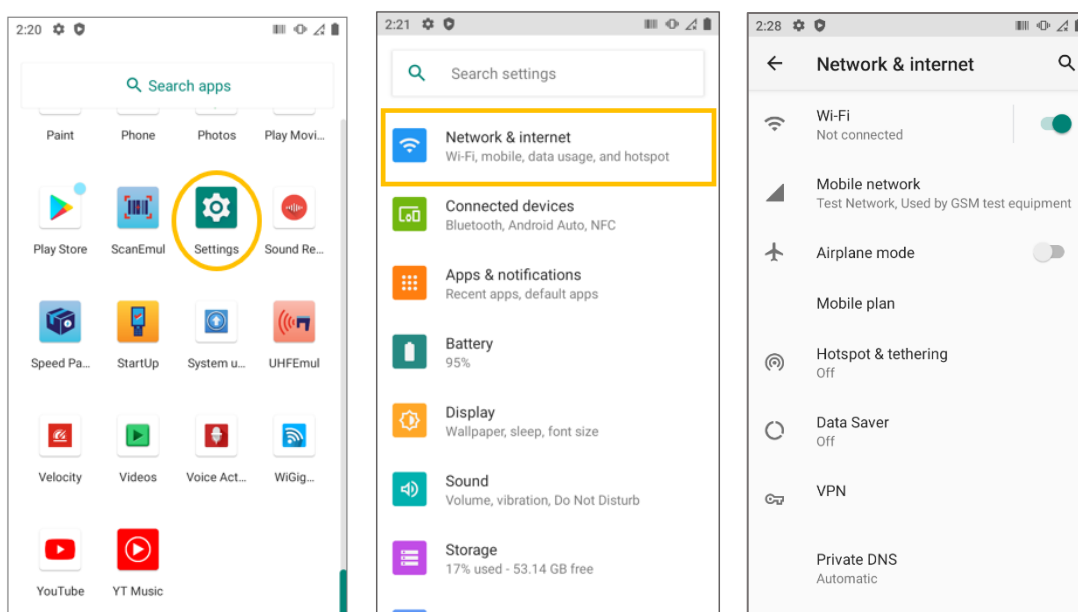

Connecting to a Wi-Fi network

To connect to an AP, perform the following procedure:

1. Select “Wi-Fi” menu of the  Settings icon.
2. In the list, select an AP name to access. If necessary, enter password to complete the access.

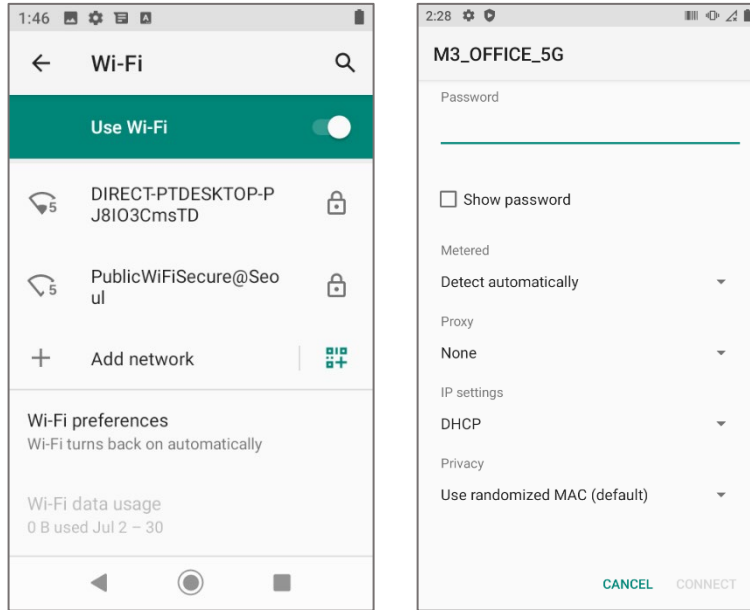

3. You can also create a QR code to share your network and connect other devices through the shared QR code without entering your Wi-Fi password.

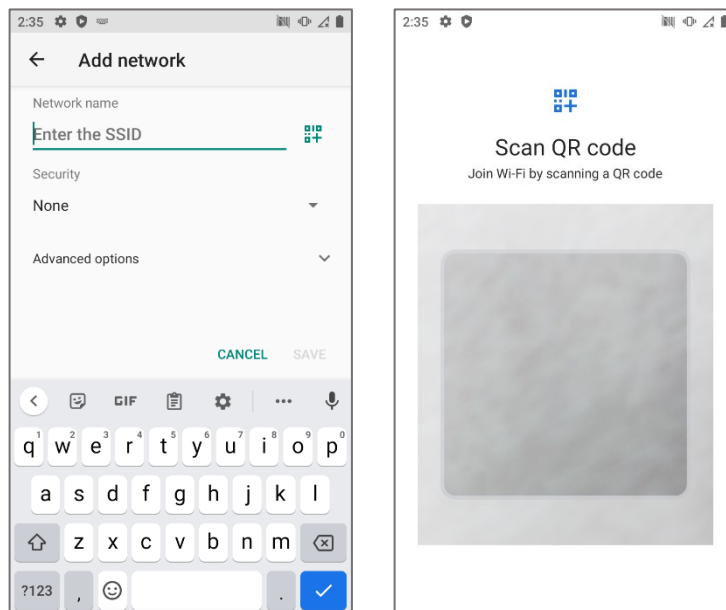



3.3 Scanner

M3 SM20 provides 1D/2D or Long-range scanner as an option. For detailed information on available options, please contact the local distributor or refer to our Web site. (Homepage: <http://www.m3mobile.net>).

3.3.1 How to Use Scanner

M3 Mobile provides the program() needed to use a scanner by default. It is the keyboard wedge program that sends barcode data.

The ScanEmul() program can be used regardless of 1D/2D scanner.

 In case of 2D scanner, it cannot be simultaneously used with a camera.

3.3.2 Using the Scanner

Place the device toward a targeted barcode and press Scan button.



The laser beam of the scanner should completely cover barcode as shown in the following.

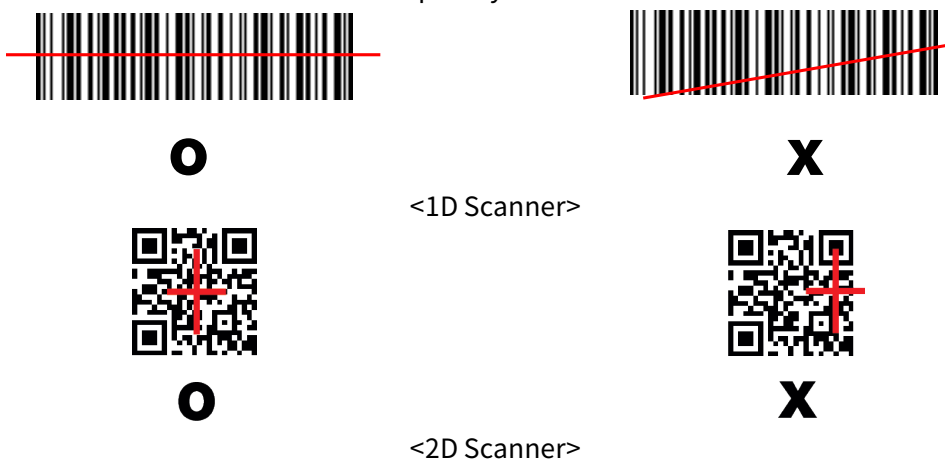

- Do not look at the laser beam directly.
(CLASS 2 LASER PRODUCT 1.0 mW, MAX OUTPUT: 650 nm)
- If the device is used for purposes other than that described in this manual, a user may be exposed to harmful electromagnetic waves.

3.4 Bluetooth

3.4.1 Setting the Bluetooth Feature

A Bluetooth device frequently used can be registered, or M3 SM20 can be searched in another device.

Activating the Bluetooth feature

Swipe the bottom → Click  Settings → Connected devices → Connection preferences → Bluetooth → + Pair new device (List of devices available to connect to is displayed)

If Bluetooth signal is turned on, Bluetooth icon () is displayed in the Status bar indicating that the Bluetooth feature is activated.

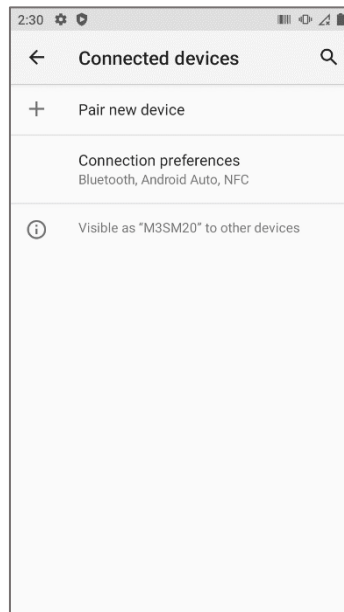
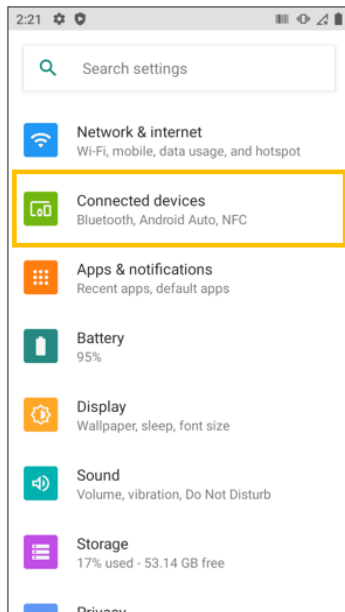

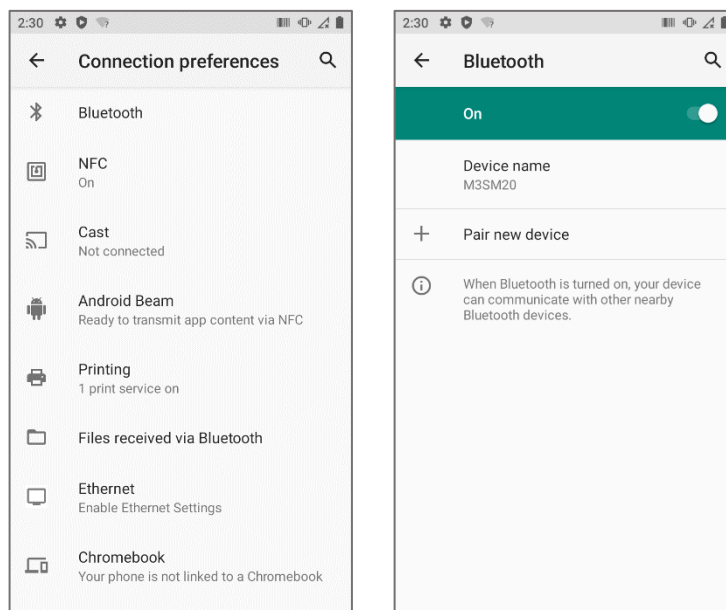

3.4.2 Connecting Using Bluetooth

List of devices available to connect to is displayed

If the “Bluetooth pairing request” screen is displayed, enter PIN code of the Bluetooth device to complete access to the device.

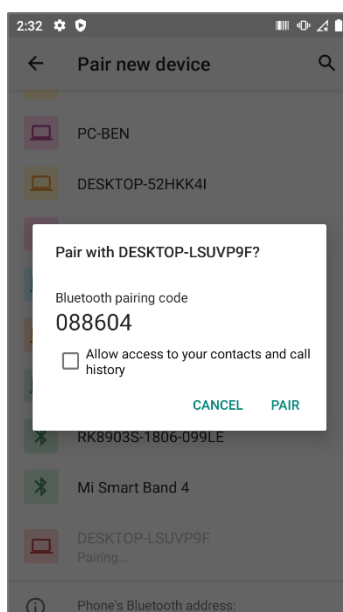

Guide on distance between the device and user



- The device is tested in general conditions wherein the device is 0.5 cm apart from a user.
- To meet the radiation safety and protection standards of the Ministry of Science, ICT and Future Planning, the device and the antenna should be 0.5 cm or more from a user regardless of the antenna use.

- It is recommended to refrain from using a metal belt clip, case, or accessory.
- Do not wear an accessory keeping 0.5 cm or shorter from the back part of the device or one that does not meet the radiation safety and protection standards of Ministry of Science, ICT and Future Planning.

3.5 NFC

3.5.1 Setting the NFC Feature

Activating the NFC Feature

There is an NFC antenna next to the speaker behind the SM20 device, so please orient it and tag it.

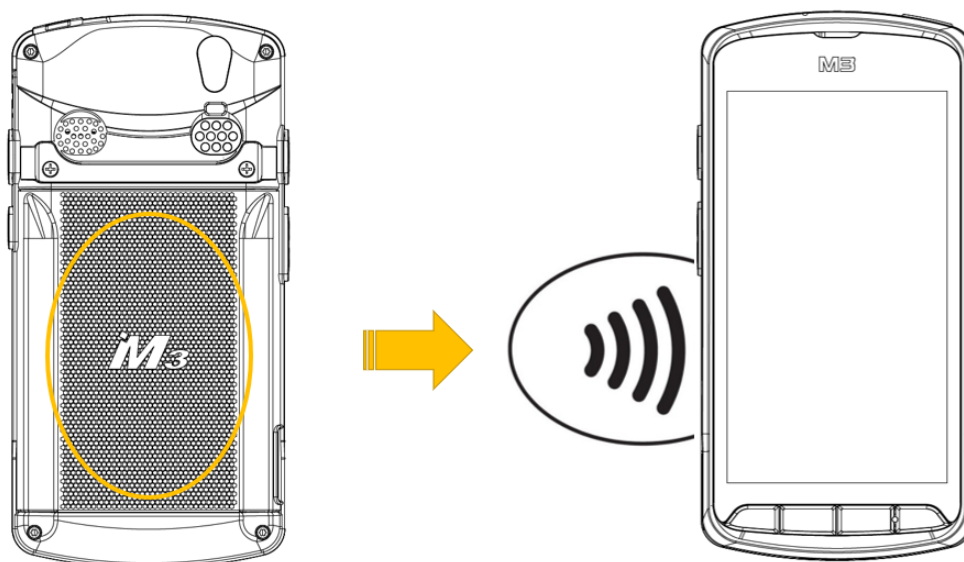

Swipe the bottom → Click  Settings → Connected devices → Connection preferences
→ NFC On

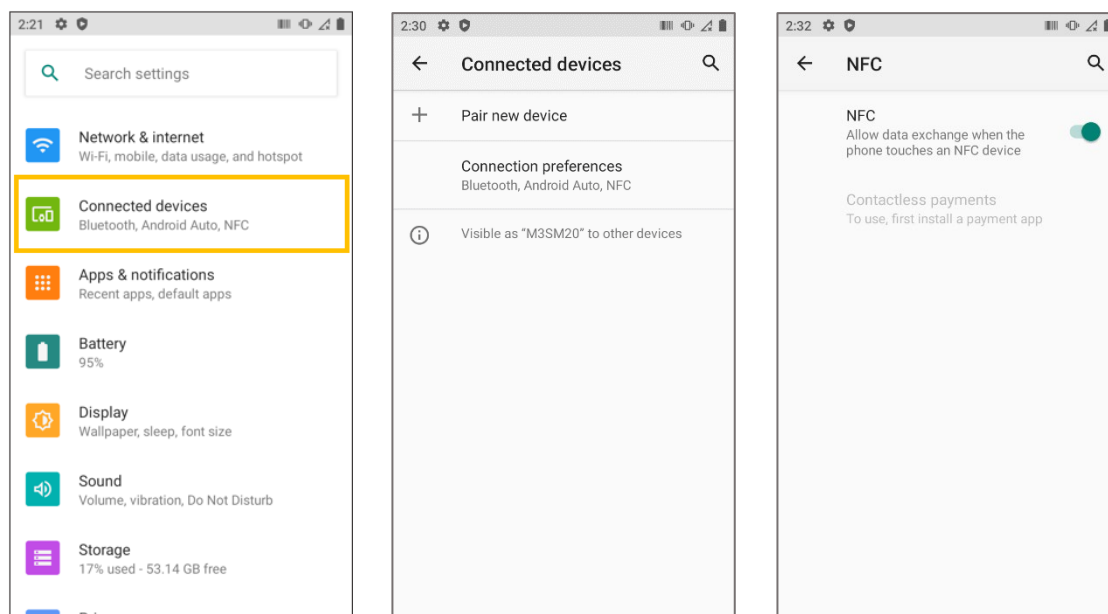

3.5.2 Connecting the NFC Feature

Connecting with the NFC Device

- Open Web page or screen of a video, photo, or contact.
- Place back part of the NFC device toward back part of M3 SM20.
- Touch the screen. Data transfer would then start.

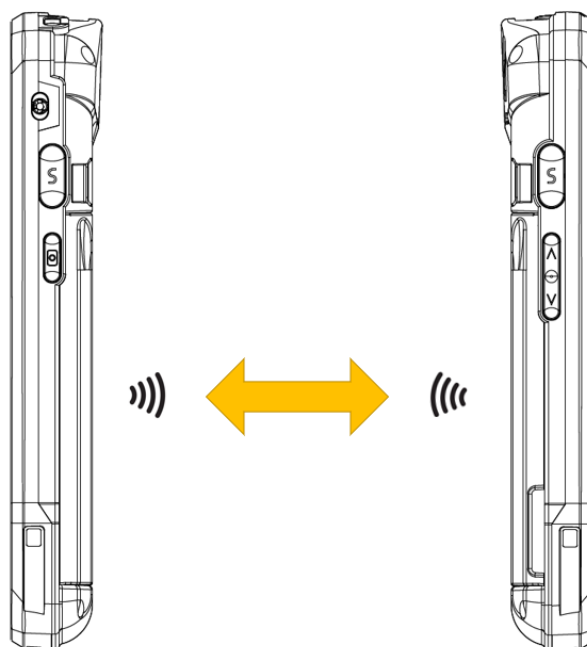

Caution when sharing data

While sharing data, the distance between devices should be less than 5 cm.

Caution when transferring data

When transferring data between devices, they do not need to be close. It is recommended to keep the distance between devices within 10 m.

Connecting to the NFC Chip / Tag Card

1. Hold M3 SM20 as shown below. Do not cover the antenna area of a speaker with your hands.
2. Place M3 SM20 near NFC chip or tag card until data transfer is completed. (Generally, data is displayed in the application.)

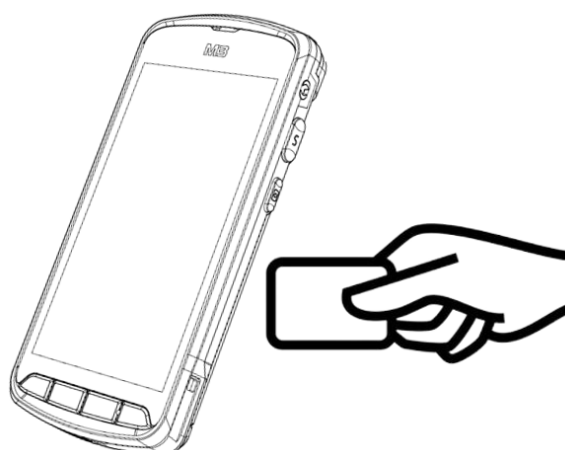

Connecting to a Bluetooth Device with the NFC Feature

1. Do not cover the antenna area of a speaker with your hands.
2. Place M3 SM20 near the device. The device displays that connection is successfully performed.

4 Advanced Use

4.1 OS Update

The M3 Mobile distributes new OS to improve the quality and performance of a product.

To check OS version of the device, **Swipe the bottom** → Click  **Settings** → **About Phone**
→ **Android version**

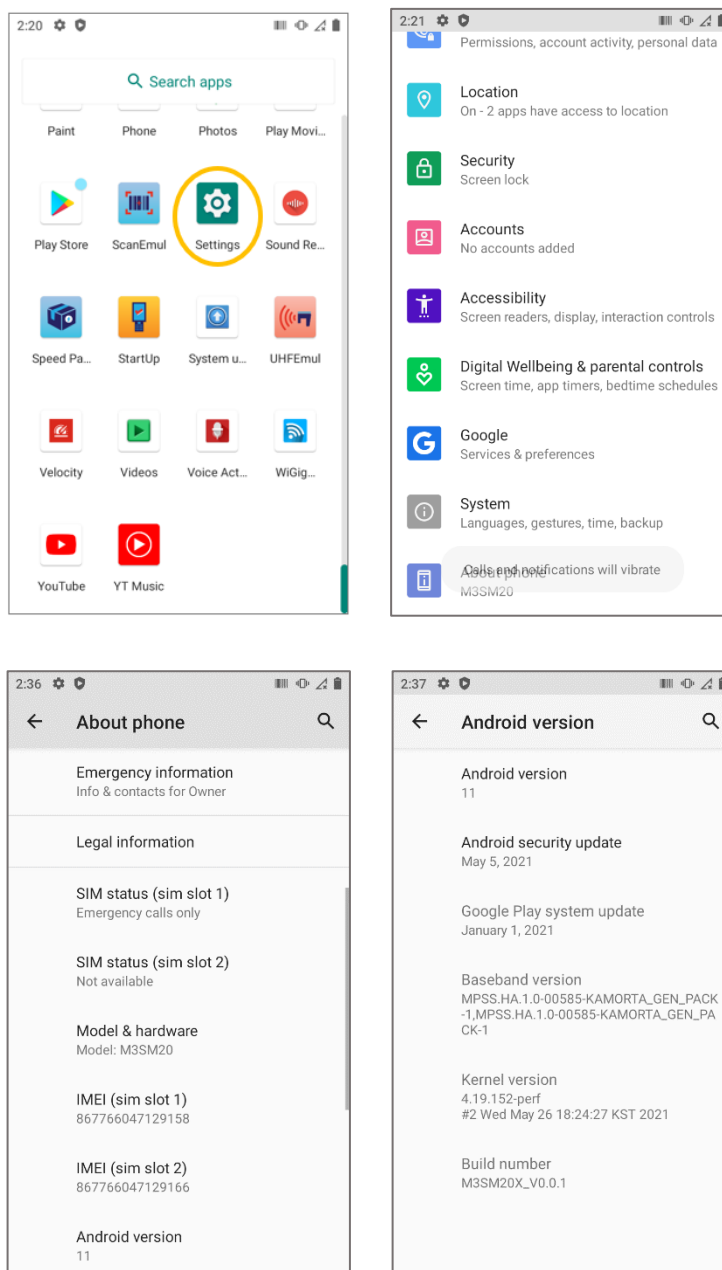

The latest OS is described on the online support page of M3 Mobile.

The OS of M3 SM20 can be updated through two methods.

- Use Micro-SD card
- Connect the device via Ethernet cradle

For detailed information on OS update, please refer to the “OS” item of the M3 FAQ (FAQ [download](#)).

4.2 Key Setting Conversion

M3 SM20 allows a user to change and modify key settings for user convenience.

Swipe the bottom → Click  KeyTool application.

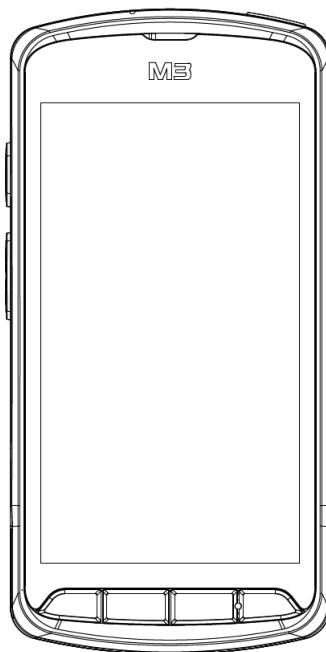
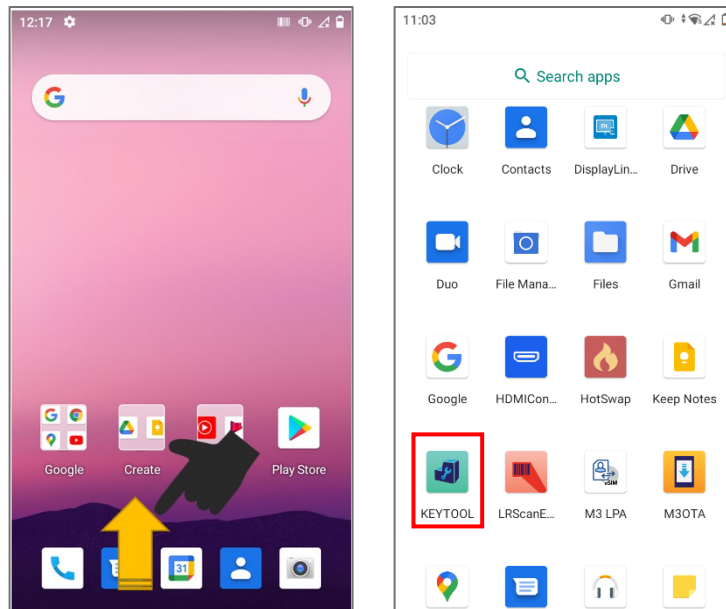

Keys can be set as follows:

SM20 KEYTOOL application KeyTool 

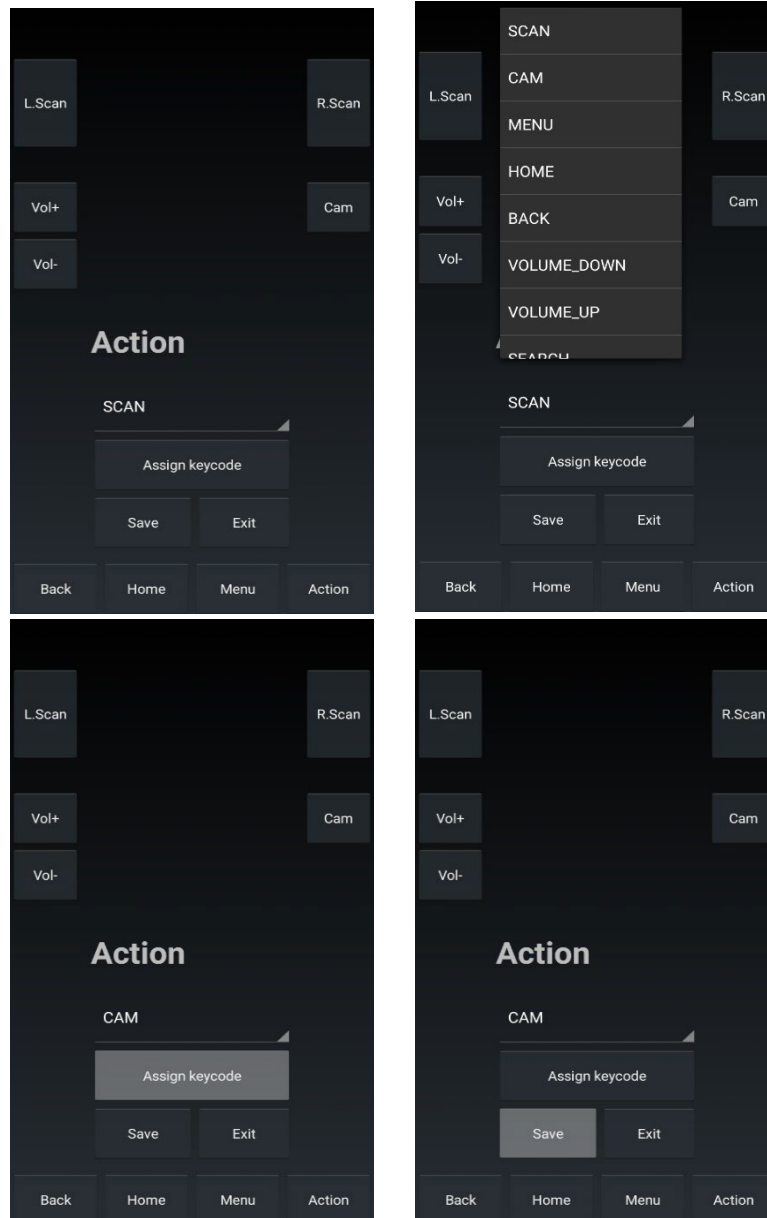

The setting of the device's physical buttons, except for Power button, can be changed.

4.3 Battery Hot swap

Sometimes people want to swap the battery without rebooting a device.

Because,

- 1) Not saved application data is erased when device is rebooted.
- 2) Rebooting Time is too long.

Battery Hot swap function prevents this situation.

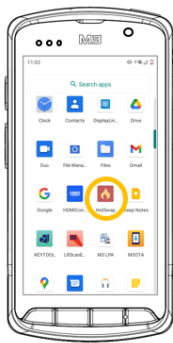

1. Run **M3 HotSwap** application.



2. You can't use the app until 2 minutes after booting.

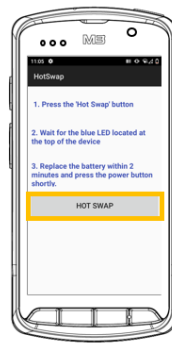

3. Press 'Hot Swap' when the application is activated.

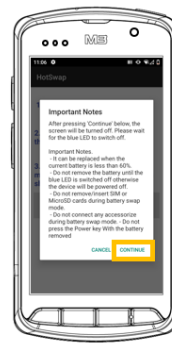

4. Press 'CONTINUE' after you finish reading the Important Notes.

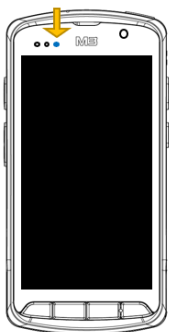

5. The blue LED will light up at first, and the LED will disappear in a few seconds.

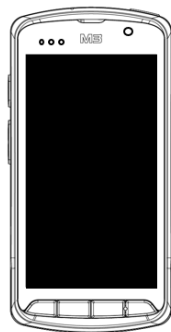

6. Remove the battery in use.

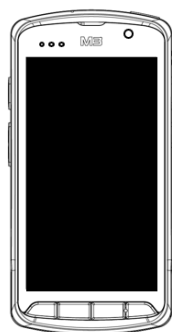

7. The sleep mode continues until a new battery is inserted.

8. Replace with a new battery.



5. Press the power button shortly.



1. Be sure to remove the battery after the blue LED disappears.
2. Replace new battery within 2 minutes and press the power button shortly.

4.4 Fast Charging

The SM20 battery has added fast charging, which is performance to charge battery faster than the previous battery charging function.

When you use fast charging function, you can keep it faster as much as about half an hour.

By using a PCM(Protection Circuit Module) in each cell, more current is used, which improves charging times and eliminates risk of battery explosion due to overcurrent. So, you can experience faster charging time than before.



Caution when Charging

While charging, must use 5V/5A power adapter.

Must use SM20 series compatible accessories.

5 Others

5.1 SM20 series Device Specifications

| Physical Characteristics | |
|--|--|
| Dimensions | 76.4 x 154.6 x 22 mm |
| Weight | 270 g (including standard battery) |
| Display | 5.0" HD IPS, 1280 x 720 pixels, Color Display |
| Touch panel | Corning Gorilla Glass touch panel supports dual input mode with finger, gloved finger, and stylus (conductive stylus sold separately) |
| Backlight | LED backlight display |
| Expansion Slot | User accessible MicroSD with 32GB SDHC and up to 512GB SDXC |
| SIM Slots | 1 Mini SIM and 1 eSIM |
| Connections | USB 2.0 High Speed OTG (host/client), WLAN, Bluetooth and WWAN |
| Notification | Audible tone, multi-color LEDs, vibration |
| Keypad | Volume + / - key, Camera key, Power key, 2 Scanner keys (Left, Right), 4 Bottom keys (Home, Back, Menu, Function) |
| Voice | Internal speaker, Two microphone with noise cancellation; vibrate alert and Bluetooth wireless headset support; High quality speaker phone; |
| Audio | Built-in speaker and microphone |
| Performance Characteristics | |
| CPU | Qualcomm® Snapdragon™ 662 Octa core processor 2.0Ghz With Adreno 610 GPU |
| OS | Android 11(Up to Android 13) with M3 Mobile's StartUp for control over GMS and other services; will support future Android releases. |
| Memory | DDR4 4GB/64GB UFS Flash |
| Power | All models ship with rechargeable Li-Ion, 3.8V, 4,100mAh smart battery, hot swap support with temporary WWAN/WLAN/Bluetooth session persistence, 6,150mAh Extended batteries(optional) |
| Data Capture | |
| Scanning | SE4710, SE55 Optional: SE4750 MR, SE4720 |
| Camera | Front CAM: 5M pixels, Rear CAM: 16M pixels auto-focus (PDAF) |
| NFC | ISO 14443 A/B, ISO 15693, Mifare, P2P mode and Card Emulation via Host (HCE) support |
| Wireless WAN Data AND VOICE COMMUNICATIONS | |
| Radio Frequency Band | LTE FDD: 800/850/900/1800/2100/2600 (1/3/5/7/8/20); LTE TDD: 2600 (38); UMTS/HSDPA/HSPA+: 850/900/2100(1/5/8); GSM/GPRS/EDGE: 850/900/1800 (3/5/8); |
| GPS | GPS/Glonass/BeiDou/Galileo/QZSS/SBAS and A-GPS |
| Wireless LAN | |
| Radio | IEEE 802.11 a/b/g/n/ac/d/e/h/i/k/r/w, ax-ready, ac Wave 2 |
| Data Rates | 5GHz: 802.11a/n/ac/ax — up to 433 Mbps 2.4GHz: 802.11b/g/n — up to 72 Mbps |

| | |
|---|--|
| Operating Channels (depending on Regulatory) | Channel 1-13 (2412-2472 MHz): 1,2,3,4,5,6,7,8,9,10,11,12,13 Channel 36-165 (5180-5825 MHz): 36,40,44,48,52,56,60,64,100,104,108,112,116,120,124,128,132,136,140,144,149,153,157,161,165 Channel Bandwidth: 20, 40, 80 MHz Actual operating channels/ frequencies and bandwidths depend on regulatory rules and certification agency. |
| Security and Encryption | WEP (40 or 104 bit); WPA/WPA2 Personal (TKIP, and AES); WPA3 Personal (SAE); WPA/WPA2 Enterprise (TKIP and AES); WPA3 Enterprise (AES) EAP-TTLS (PAP, MSCHAP, MSCHAPv2), EAP-TLS, PEAPv0-MSCHAPv2, PEAPv1-EAP-GTC, LEAP and EAP-PWD; WPA3 Enterprise 192-bit Mode (GCMP256) — EAP-TLS; Enhanced Open (OWE) |
| Fast Roam | PMKID caching; Cisco CCKM; 802.11r; OKC |
| Wireless PAN | |
| Bluetooth | Bluetooth 5.1, Bluetooth Low Energy (BLE) Support |
| Regulatory | |
| EMI/EMC | EN 301 489-1; EN 301 489-3; EN 55024; EN 55032 Class A |
| Electrical Safety | IEC 62368-1, EN 62368-1 |
| RF Exposure | EU: EN 50364, EN 62369-1, EN 50566, EN 62311 |
| User Environment | |
| Temperature | Operating Temperature: -4° F to 140° F/-20° C to 60° C Storage Temperature: -22°F to 176°F/-30°C to 80°C |
| Humidity | 5% to 95% RH (Non-condensing) |
| Tumble Test | 0.5m/1000Cycle, 1m/500Cycle (with Boots) |
| Drop Test | 1.2m / 1.8m (with bumper boot) |
| Sealing | IP65 / IP67(Optional) |
| Vibration | Sine: 4g's peak, 5hz to 2khz, Random: .04g ² /hz, 20hz to 2khz |
| Thermal Shock | -40° F to 158° F/-40° C to 70° C |
| ESD | +/- 15kV air, +/-8kV contact discharge, +/-8kV indirect contact discharge |
| Interactive Sensor Technology (IST) | |
| Light Sensor | Automatically adjusts the brightness of the display |
| Magnetometer sensor | eCompass automatically detects direction and orientation |
| Motion Sensors | Gyro Sensor, Accelerometers: for X, Y, and Z movement, and gyroscopes for measuring the extent and rate of rotation in space |
| Proximity Sensor | Detect the presence of nearby objects without any physical contact, during a telephone call, proximity sensors play a role in detecting accidental touchscreen taps |
| Environmental Compliance | |
| Directive 2011/65/EU, Directive(EU)2015/863 | |
| Warranty | |
| Subject to the terms of M3Mobile's hardware warranty statement, the SM20 series are warranted against defects in workmanship and materials for a period of 1 (one) year from the date of shipment. For complete warranty statement. | |

5.2 Service

If you have any questions or complaints with using our product, please contact M3 Service Center or visit our Web site (<http://itc.m3mobile.net>). We do our best to immediately respond to your inquiry.

The M3 FAQ document may help resolve general problems.

For any questions on work programs, please contact the program supplier for faster service.

5.2.1 Contacts

- **Head Office**

4F, Namjeon Bldg, 44, Gu-ui Gangbyeon-ro, Gwangjin-gu, Seoul, Korea, 05116

Tel: +82 2 574 0037, Fax: +82 2 558 1253

www.m3mobile.net, sales@m3mobile.co.kr, sales_eu@m3mobile.co.kr

- **Service Center**

Chun-ui Techno Park 201-610, 202, Chunui-dong, Wonmi-gu, Bucheon, Gyeonggi-do, 420-857, Korea

Tel: +82 32 623 0037, Fax: +82 70 4015 6323, cs@m3mobile.co.kr

- **ITC (M3 Mobile Information & Technology Center)**

<http://itc.m3mobile.net>, it@m3mobile.co.kr

- **M3 Mobile GmbH**

M3 Mobile GmbH, Am Holzweg 26 65830 Kriftel, Germany

Tel: +49 6190/8021828, sales@m3mobile.co.kr

