

**M3 MOBILE**















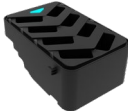

Wearable

**WR10**

**Accessories Guide**



# WR10 ACC. MAP

| Battery Charger   | Power Supply   | Battery  | Ring Trigger   | Glove  | etc  |
|---|--|--|--|--|--|
| <p><b>3 SLOT Battery Charger</b></p>  <p>3-Slot Battery Charger<br/>WR10-03BC-U00</p>  |  <p>Provides power to<br/>WR10/15 directly and<br/>3 Slot Battery Charger<br/>WR10-PWSP-CEU</p> |  <p>Battery(1,000mAh)<br/>WR10-BATT-S10</p> |  <p>WR10-TRIG-S00</p> |  <p>WR15-GLOV-GRS<br/>WR15-GLOV-GLS</p> |  <p>Wrist strap<br/>WR10-STRP-W01</p> |
| <p><b>8-24 SLOT Battery Charger</b></p>  <p>8-Slot Battery Charger<br/>WR10-08BC-U00<br/>WR10-08BC-C00</p>  <p>16-Slot Battery<br/>Charger<br/>WR10-16BC-C00</p>  <p>24-Slot Battery<br/>Charger<br/>WR10-24BC-C00</p> |  <p>Power Supply for<br/>8-Slot BC<br/>WR10-PWSP-1XX</p>  |  |  |  |  <p>Neck Strap<br/>WR10-STRP-N01</p>  |
| <p><b>16 SLOT Battery Charger</b></p>  <p>32-Slot Battery Charger<br/>WR10-32BC-U00<br/>WR10-32BC-C00</p>  |  <p>Power Supply for<br/>32-Slot BC<br/>WR10-PWSP-4XX</p>                                       |  |  |  |  <p>USB cable /<br/>WR10-CABL-UCA</p> |
| <b>Battery Charger Bridges / Clip</b>   |  |  |  |  |  |
| <p><b>16-32 SLOT Battery Charger Bridge / Clip</b></p>  <p>16-32 Slot Clip<br/>UNIV-BTCH-CLP</p>  <p>16-32 Slot Bridge<br/>UNIV-BTCH-BRG</p>  |  |  |  |  |  |

Battery Charger

# 3-Slot Battery Charger

WR10-03BC-U00

---



I/O USB Type-C



Input 5VDC / 2A



Dimension 56 x 39 x 83mm



Weight 100g

## Compatible

---



**WR10/15 Battery**  
(WR10-BATT-S10)



**Provides power to  
WR10/15 directly and  
3 Slot Battery Charger**  
(WR10-PWSP-CEU)

Battery Charger

# 8-Slot Battery Charger

WR10-08BC-U00  
WR10-08BC-C00

---



I/O DC



Input 12VDC / 3A



Dimension 96.9 x 143.4 x 53.7mm



Weight 370g

## Compatible

---



**WR10/15 Battery**  
(WR10-BATT-S10)



**Power Supply**  
(WR10-PWSP-1XX)

Battery Charger

# 16-Slot Battery Charger

WR10-16BC-C00

---



I/O

DC



Input

12VDC / 7A



Dimension

189 x 143.5 x 55mm



Weight

740g

## Compatible

---



**WR10/15 Battery**  
(WR10-BATT-S10)



**Power Supply**  
(WR10-PWSP-1XX)

Battery Charger

# 24-Slot Battery Charger

WR10-24BC-C00

---



I/O

DC



Input

12VDC / 7A



Dimension

281 x 143.5 x 55mm



Weight

1,100g

## Compatible

---



**WR10/15 Battery**  
(WR10-BATT-S10)



**Power Supply**  
(WR10-PWSP-1XX)

Battery Charger

# 32-Slot Battery Charger

WR10-32BC-U00

WR10-32BC-C00

---



I/O

DC



Input

12VDC / 7A



Dimension

377.9 x 143.5 x 55mm



Weight

1,480g

## Compatible

---



**WR10/15 Battery**  
(WR10-BATT-S10)



**Power Supply**  
(WR10-PWSP-4XX)

Battery Charger Bridges / Clip

# 16-32 Slot Clip

UNIV-BTCH-CLP

---

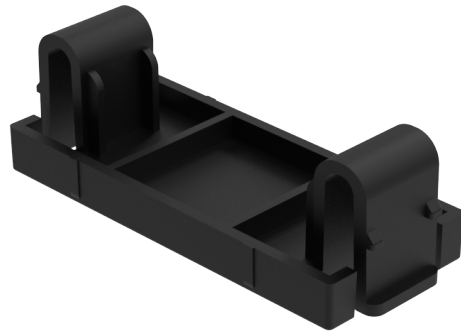

Dimension 37 x 15.2 x 11.5mm



Weight 1g

Compatible

---



**WR10/15**  
**16 Slot Battery Charger**  
(WR10-16BC-C00)



**WR10/15**  
**24 Slot Battery Charger**  
(WR10-24BC-C00)



**WR10/15**  
**32 Slot Battery Charger**  
(WR10-32BC-U00)

Battery Charger Bridges / Clip

# 16-32 Slot Bridge

UNIV-BTCH-BRG

---

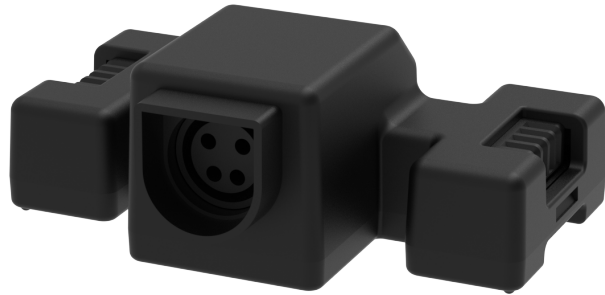

**Dimension** 68 x 48 x 25mm



**Weight** 21g

## Compatible

---



**WR10/15**  
**16 Slot Battery Charger**  
(WR10-16BC-C00)



**WR10/15**  
**24 Slot Battery Charger**  
(WR10-24BC-C00)



**WR10/15**  
**32 Slot Battery Charger**  
(WR10-32BC-U00, WR10-32BC-C00)

# Guide to Expanding an 8-Slot Battery Charger to 16–32 Slots Using Bridges and Clips

! Please connect and secure the 8-slot unit and the 8-slot battery charger using the clips and bridge as shown in the image.

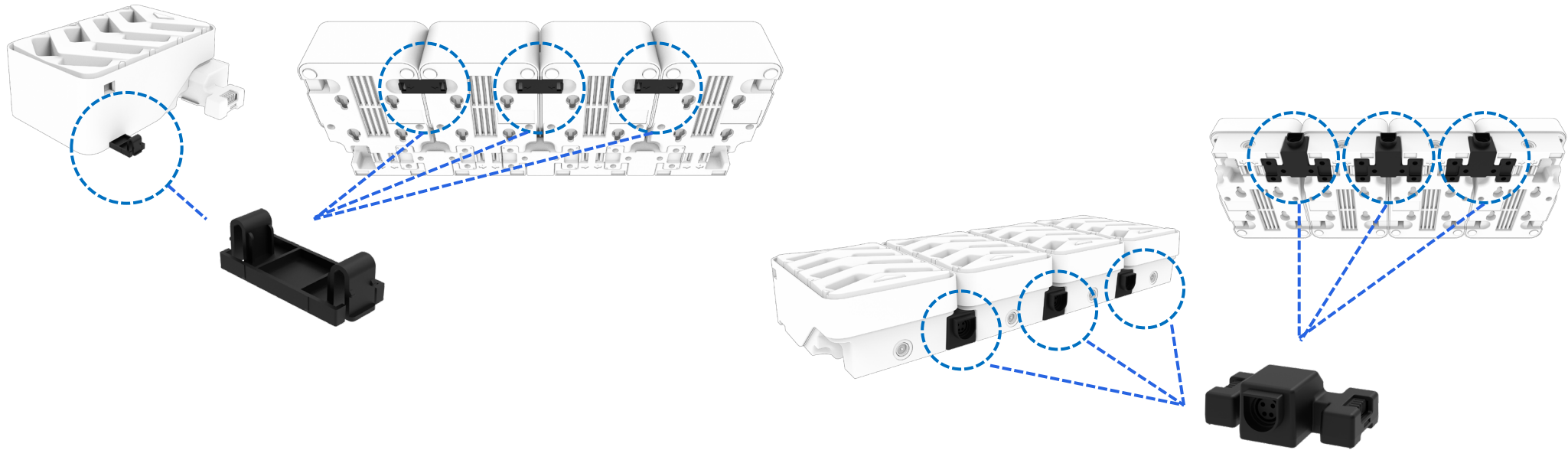

## Bridge & Clip Quantity per Slot

- 16-Slot Battery Charger : 1clip + 1 Bridge
- 24 Slot Battery Charger : 2clip + 2 Bridge
- 32 Slot Battery Charger : 3clip + 3 Bridge

Power Supply / Charging

# Provides power to WR10/15 directly

WR10-PWSP-CEU

---



Input 100~240VAC



Output 5VDC / 2A

Compatible

---



WR10/15



**3-Slot Battery Charger**  
(WR10-03BC-U00)

Power Supply / Charging

# Power Supply for 8-24 Battery Charger

WR10-PWSP-1XX



Input 100~240VAC



Output 12VDC / 3A

## Compatible



WR10/15  
8 Slot Battery Charger  
(WR10-08BC-U00, WR10-08BC-C00)



WR10/15  
16 Slot Battery Charger  
(WR10-16BC-C00)



WR10/15  
24 Slot Battery Charger  
(WR10-24BC-C00)

Depending on the type of connector at the end

**WR10-PWSP-1EU/KR**

Power Supply / Charging

# Power Supply for 32 Battery Charger

WR10-PWSP-4XX

---



Compatible

---



WR10/15  
32 Slot Battery Charger  
(WR10-32BC-U00, WR10-32BC-C00)

Depending on the type of connector at the end

**WR10-PWSP-4EU/KR**



Input 100~240VAC



Output 12VDC / 7A

Battery

# Battery(1,000mAh)

WR10-BATT-S10

---



Dimension 48.7 x 32.6 x 13.25mm



Weight 30g

Compatible

---



WR10/15

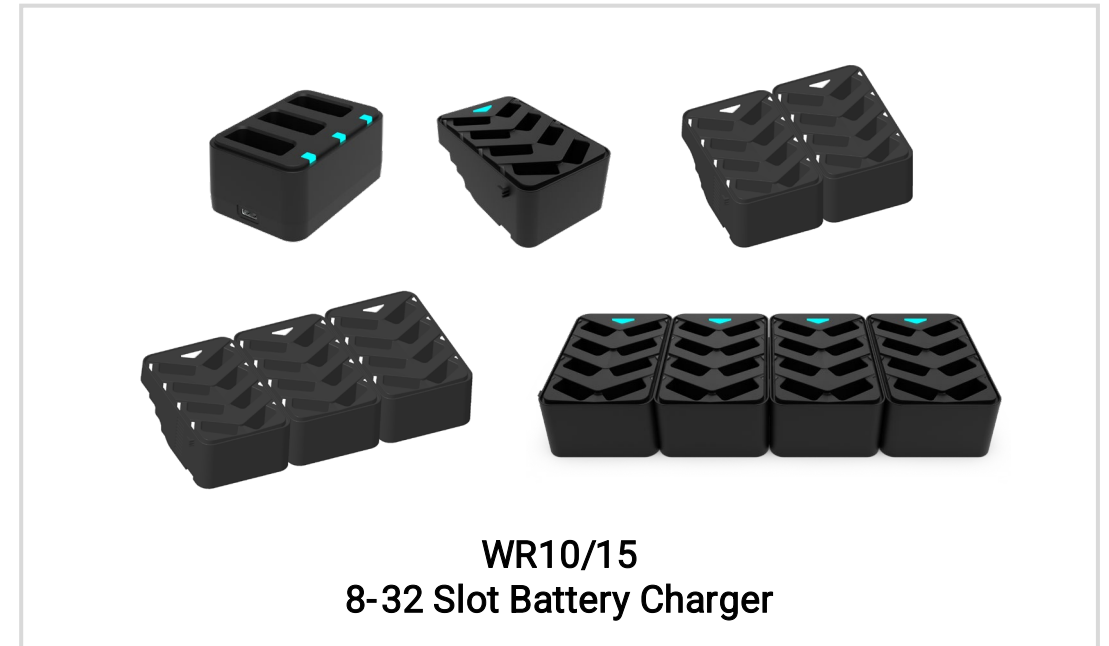

Ring Trigger

# Ring Trigger

WR10-TRIG-S00



Dimension 648 x 36.5 x 28mm



Weight 20g

Compatible





WR10/15

# Glove Glove

WR15-GLOV-GRS  
WR15-GLOV-GLS

---



|   |           |                   |
|---|-----------|-------------------|
|  | Dimension | 648 x 36.5 x 28mm |
|  | Weight    | 20g               |

\*\*\* Accessory only. WR10/WR15 device not included.  
Images for reference only.

## Compatible

---



WR10/15

## SKU Details

---

| SKU           | Description  |
|---------------|--|
| WR15-GLOV-GRS | WR15 Glove Mount for <a href="#">right hand, standard size</a> |
| WR15-GLOV-GLS | WR15 Glove Mount for <a href="#">left hand, standard size</a>  |

ETC. / Miscellaneous

**ETC.**

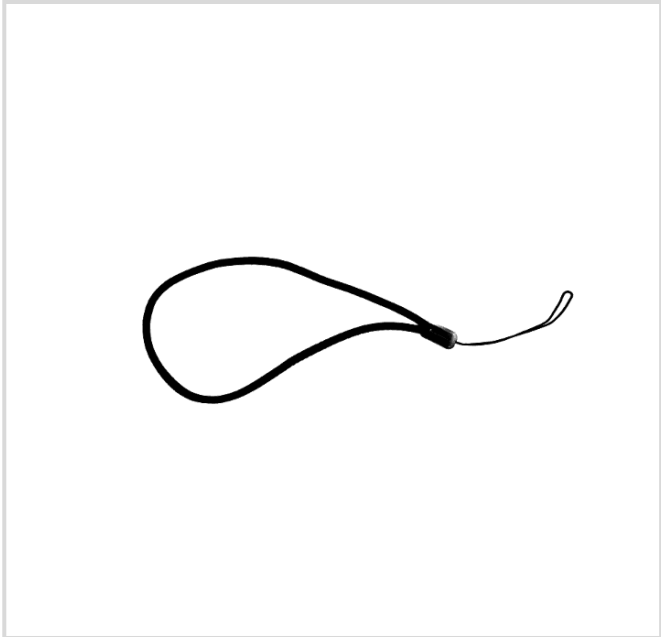

WR10-STRP-W01  
Wrist strap



WR10-STRP-N01  
Neck Strap



WR10-CABL-UCA  
USB C-type cable

# WR10

# Accessories Package

Configuration by SKU

Package

# SE5500 Scanner package



**WR10-WERS-U20**  
SE5500 Scanner Package



**Ring Scanner (SE5500)**  
+ **Battery (WR10-BATT-S10)**

+



**Ring Trigger**  
(WR10-TRIG-S00)

+



**Wrist Strap**  
(WR10-STRP-W01)

+



**USB C-type cable**  
(WR10-CABL-UCA)

Package

# SE5500 Scanner package



WR10-WERS-U21  
SE5500 Scanner Package



Ring Scanner (SE5500)  
+ Battery  
(WR10-BATT-S10)



Neck Strap  
(WR10-STRP-W01)

Package

# SE5500 Scanner package



WR10-WERS-U22  
SE5500 Scanner Package



Ring Scanner (SE5500)  
+ Battery (WR10-BATT-S10)

+



Ring Trigger  
(WR10-TRIG-S00)

+



Wrist Strap  
(WR10-STRP-W01)

+



USB C-type cable  
(WR10-CABL-UCA)

+



Neck Strap  
(WR10-STRP-W01)

Package

# SE4107 Scanner package



**WR10-WERS-U10**  
SE4107 Scanner Package



**Ring Scanner (SE4107)**  
+ **Battery (WR10-BATT-S10)**

+



**Ring Trigger**  
(WR10-TRIG-S00)

+



**Wrist Strap**  
(WR10-STRP-W01)

+



**USB C-type cable**  
(WR10-CABL-UCA)

Package

# SE4107 Scanner package



WR10-WERS-U11  
SE4107 Scanner Package



Ring Scanner (SE4107)  
+ Battery  
(WR10-BATT-S10)



Neck Strap  
(WR10-STRP-W01)

Package

# SE4107 Scanner package



WR10-WERS-U12  
SE4107 Scanner Package



Ring Scanner (SE4107)  
+ Battery (WR10-BATT-S10)

+



Ring Trigger  
(WR10-TRIG-S00)

+



Wrist Strap  
(WR10-STRP-W01)

+



USB C-type cable  
(WR10-CABL-UCA)

+



Neck Strap  
(WR10-STRP-W01)